



润奥电子

MTC500 MTA500 MTK500 MTX500

普通晶闸管模块

特点:

- n 芯片与底板电气绝缘,2500V 交流绝缘
 - n 全压接结构,优良的温度特性和功率循环能力
 - n 体积小,重量轻
- 典型应用:**
- n 交直流电机控制
 - n 各种整流电源
 - n 变频器

$I_{T(AV)}$ 500A
 V_{DRM}/V_{RRM} 600~1800V
 I_{TSM} 11 KA
 I^2t 605 $10^3 A^2S$

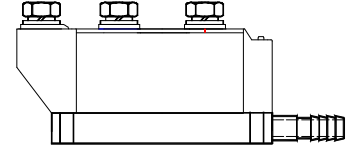

符号	参数	测试条件	结温 $T_J(^{\circ}C)$	参数值			单位
				最小	典型	最大	
$I_{T(AV)}$	通态平均电流	180° 正弦半波,50Hz 单面散热,水冷, $T_c=55^{\circ}C$	125			500	A
$I_{T(RMS)}$	方均根电流		125			785	A
V_{DRM} V_{RRM}	断态重复峰值电压 反向重复峰值电压	$V_{DRM} & V_{RRM}$ $t_p=10ms$ $V_{DSM} & V_{RSM} = V_{DRM} & V_{RRM} + 200V$	125	600		1800	V
I_{DRM} I_{RRM}	断态重复峰值电流 反向重复峰值电流	$V_{DM} = V_{DRM}$ $V_{RM} = V_{RRM}$	125			40	mA
I_{TSM}	通态不重复浪涌电流	10ms 底宽, 正弦半波,	125			11.0	KA
I^2t	浪涌电流平方时间积	$V_R=0.6V_{RRM}$				605	$A^2s \times 10^3$
V_{TO}	门槛电压		125			0.80	V
r_T	斜率电阻					0.64	mW
V_{TM}	通态峰值电压	$I_{TM}=1500A$	25			1.90	V
dv/dt	断态电压临界上升率	$V_{DM}=67\%V_{DRM}$	125			800	V/ μs
di/dt	通态电流临界上升率	$I_{TM}=1000A$, 门极触发电流幅值 $I_{GM}=1.5A$, 门极上升时间 $t_r \leq 1\mu s$	125			100	A/ μs
I_{GT}	门极触发电流	$V_A=12V, I_A=1A$	25	30		120	mA
V_{GT}	门极触发电压			1.0		2.5	V
I_H	维持电流			20		150	mA
V_{GD}	门极不触发电压	$V_{DM}=67\%V_{DRM}$	125	0.2			V
$R_{th(j-c)}$	热阻抗(结至壳)	180° 正弦波,单面散热				0.087	$^{\circ}C/W$
V_{iso}	绝缘电压	50Hz, R.M.S, $t=1min, I_{iso}:1mA(MAX)$		2500			V
F_m	安装扭矩(M10)				12		N·m
	安装扭矩(M6)				6		N·m
T_{stg}	贮存温度			-40		125	$^{\circ}C$
W_t	质量				1820		g
Outline	M463S						

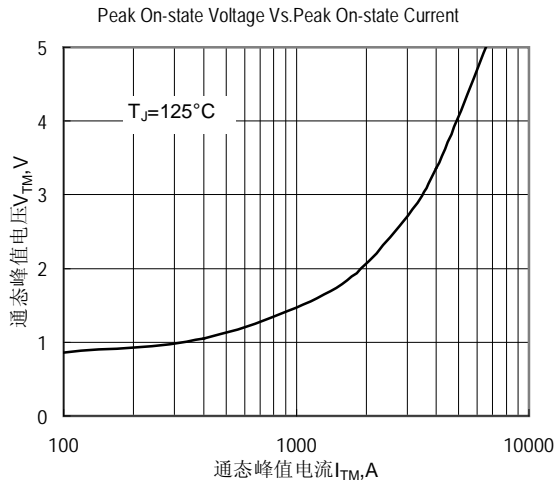

Fig.1 通态伏安特性曲线

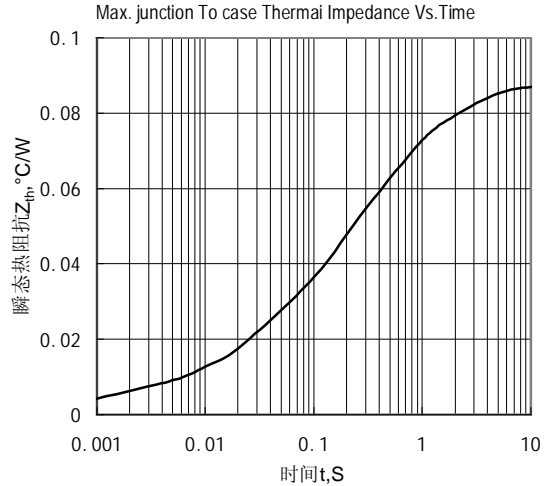

Fig.2 结至管壳瞬态热阻抗曲线

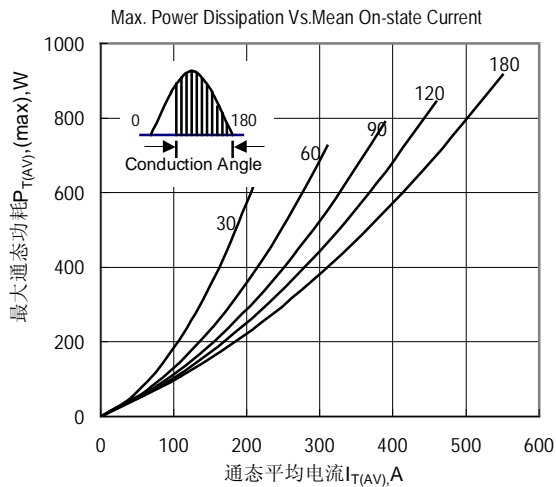

Fig.3 最大功耗与平均电流关系曲线

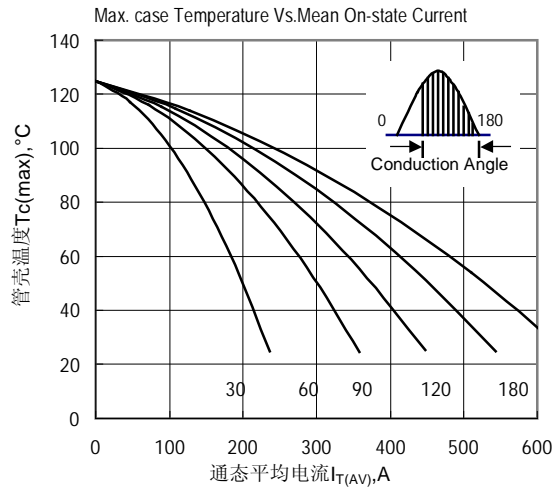

Fig.4 管壳温度与通态平均电流关系曲线

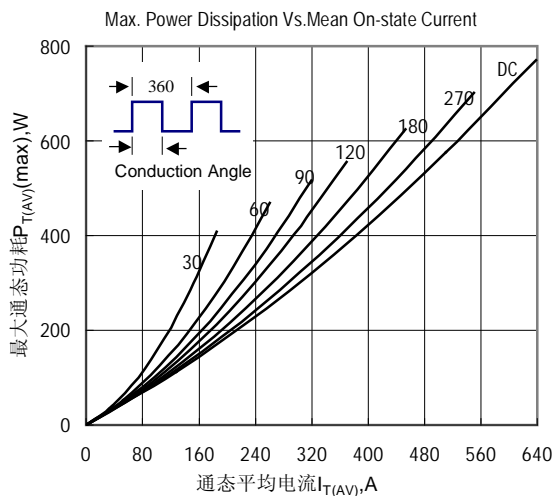

Fig.5 最大功耗与平均电流关系曲线

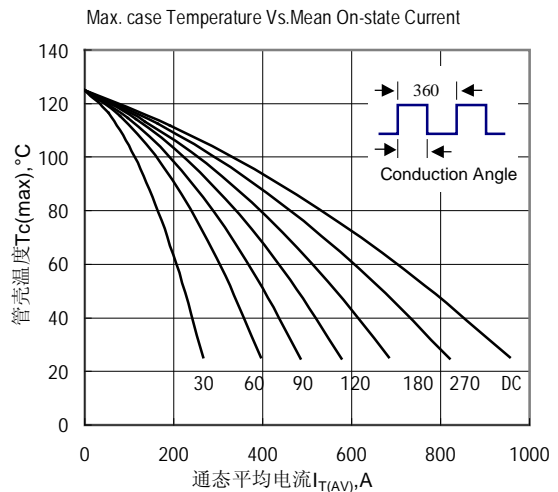

Fig.6 管壳温度与通态平均电流关系曲线

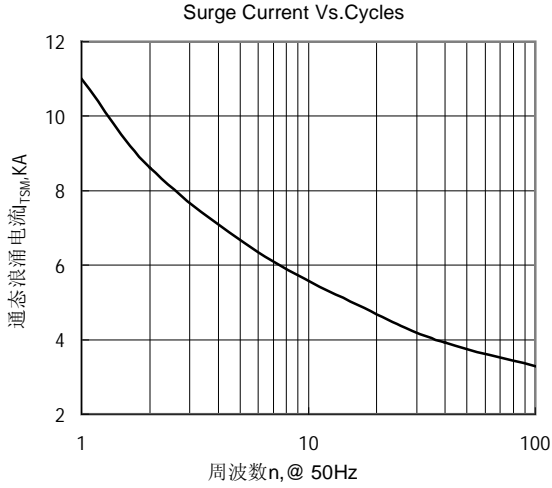

Fig.7 通态浪涌电流与周波数的关系曲线

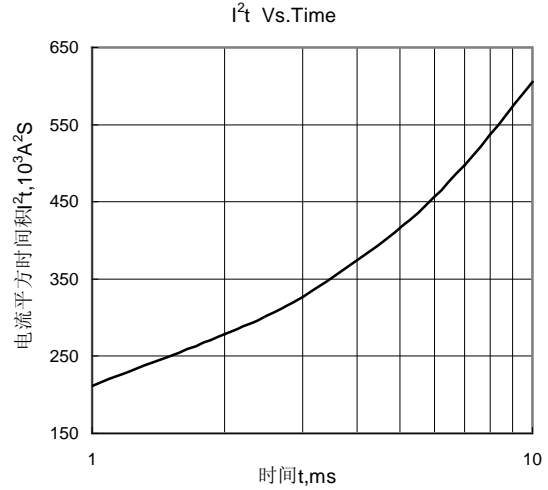

Fig.8 I^2t 特性曲线

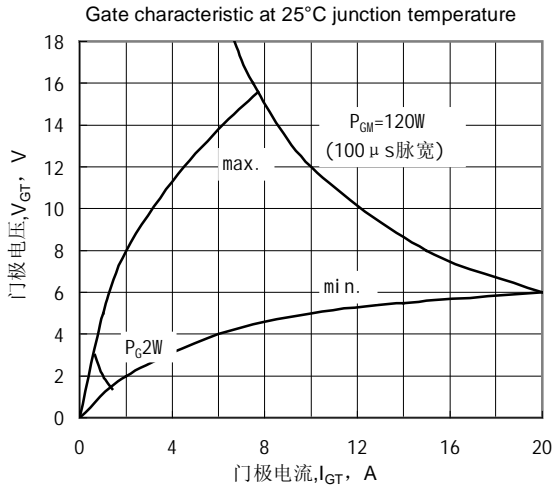

Fig.9 门极功率曲线

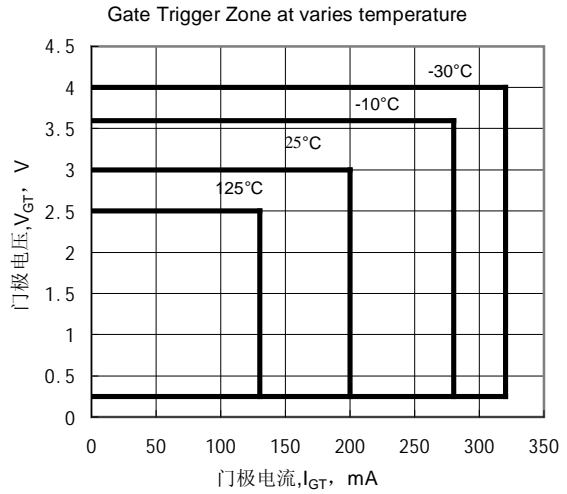
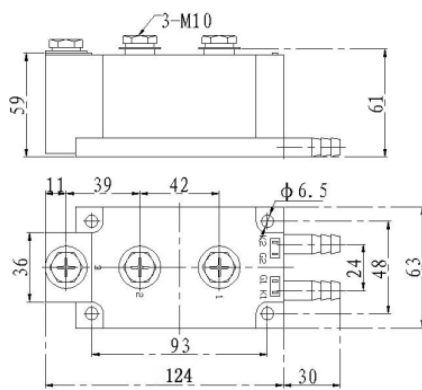

Fig.10 门极触发特性曲线

外形图:



M463S

