



润奥电子

MTC400 MTA400 MTK400 MTX400
普通晶闸管模块

特点:

- n 芯片与底板电气绝缘,2500V 交流绝缘
 - n 全压接结构,优良的温度特性和功率循环能力
 - n 体积小,重量轻
- 典型应用:
- n 交直流电机控制
 - n 各种整流电源
 - n 变频器

$I_{T(AV)}$ 400A
 V_{DRM}/V_{RRM} 600~1800V
 I_{TSM} 8.5 KA
 I^2t 361 $10^3 A^2S$

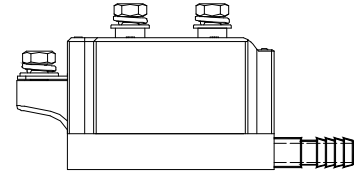

| 符号 | 参数 | 测试条件 | 结温 $T_J(^{\circ}C)$ | 参数值 | | | 单位 |
|------------------------|----------------------|---|------------------------|------|----|-------|-------------------|
| | | | | 最小 | 典型 | 最大 | |
| $I_{T(AV)}$ | 通态平均电流 | 180°正弦半波,50Hz 单面散热,水冷, $T_c=55^{\circ}C$ | 125 | | | 400 | A |
| $I_{T(RMS)}$ | 方均根电流 | | 125 | | | 628 | A |
| V_{DRM} V_{RRM} | 断态重复峰值电压 反向重复峰值电压 | $V_{DRM} & V_{RRM}$ tp=10ms $V_{DSM} & V_{RSM} = V_{DRM} & V_{RRM} + 200V$ | 125 | 600 | | 1800 | V |
| I_{DRM} I_{RRM} | 断态重复峰值电流 反向重复峰值电流 | $V_{DM} = V_{DRM}$ $V_{RM} = V_{RRM}$ | 125 | | | 30 | mA |
| I_{TSM} | 通态不重复浪涌电流 | 10ms 底宽,正弦半波, | 125 | | | 8.50 | KA |
| I^2t | 浪涌电流平方时间积 | $V_R = 0.6V_{RRM}$ | | | | 361 | $A^2s \cdot 10^3$ |
| V_{TO} | 门槛电压 | | 125 | | | 0.80 | V |
| r_T | 斜率电阻 | | | | | 0.80 | mW |
| V_{TM} | 通态峰值电压 | $I_{TM} = 1200A$ | 25 | | | 1.90 | V |
| dv/dt | 断态电压临界上升率 | $V_{DM} = 67\%V_{DRM}$ | 125 | | | 800 | V/ μs |
| di/dt | 通态电流临界上升率 | $I_{TM} = 800A$, 门极触发电流幅值 $I_{GM} = 1.5A$, 门极上升时间 $t_r \leq 1\mu s$ | 125 | | | 100 | A/ μs |
| I_{GT} | 门极触发电流 | $V_A = 12V, I_A = 1A$ | 25 | 30 | | 120 | mA |
| V_{GT} | 门极触发电压 | | | 1.0 | | 2.5 | V |
| I_H | 维持电流 | | | 20 | | 150 | mA |
| V_{GD} | 门极不触发电压 | $V_{DM} = 67\%V_{DRM}$ | 125 | 0.2 | | | V |
| $R_{th(j-c)}$ | 热阻抗(结至壳) | 180° 正弦波, 单面散热 | | | | 0.110 | $^{\circ}C/W$ |
| V_{iso} | 绝缘电压 | 50Hz, R.M.S, t=1min, $I_{iso}: 1mA(MAX)$ | | 2500 | | | V |
| F_m | 安装扭矩(M8) | | | | | 12 | N·m |
| | 安装扭矩(M6) | | | | | 6 | N·m |
| T_{stg} | 贮存温度 | | | -40 | | 125 | $^{\circ}C$ |
| W_t | 质量 | | | | | 1300 | g |
| Outline | M453S | | | | | | |

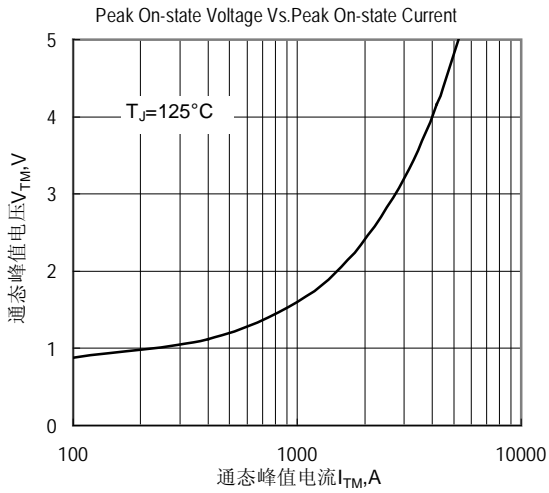

Fig.1 通态伏安特性曲线

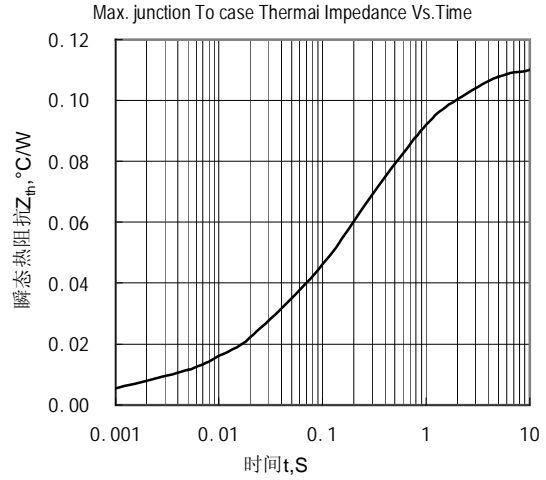

Fig.2 结至管壳瞬态热阻抗曲线

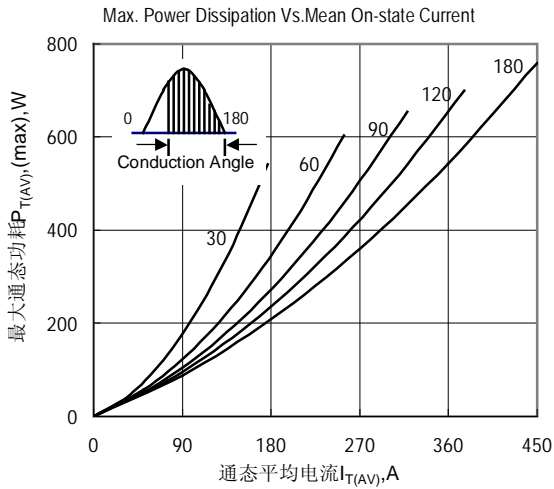

Fig.3 最大功耗与平均电流关系曲线

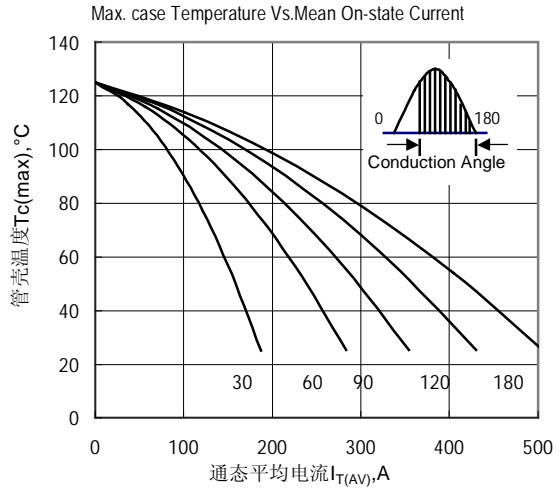

Fig.4 管壳温度与通态平均电流关系曲线

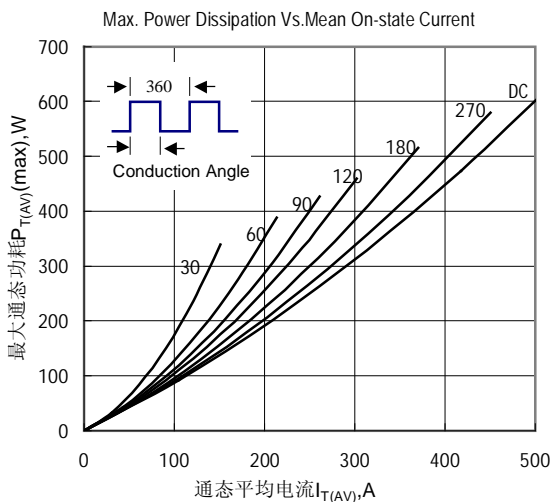

Fig.5 最大功耗与平均电流关系曲线

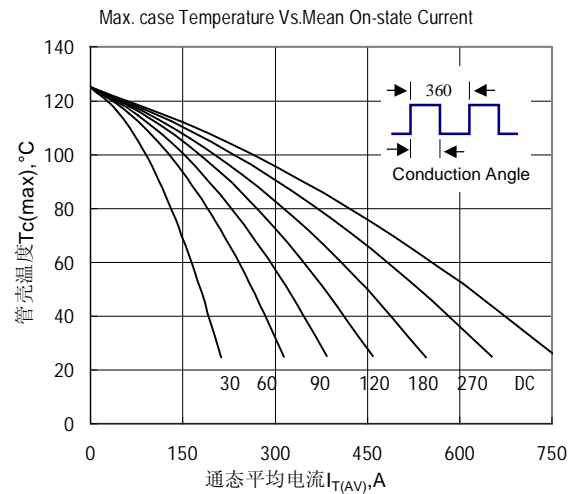

Fig.6 管壳温度与通态平均电流关系曲线

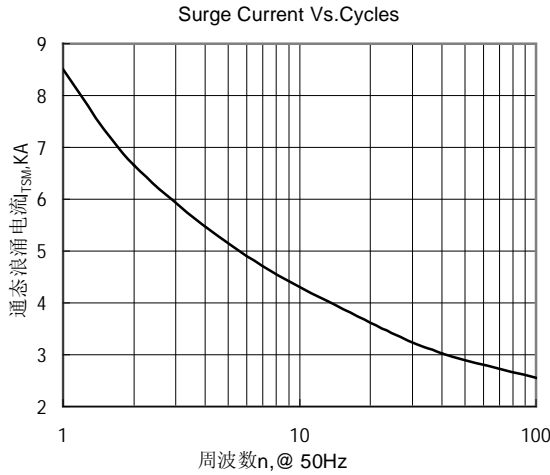

Fig.7 通态浪涌电流与周波数的关系曲线

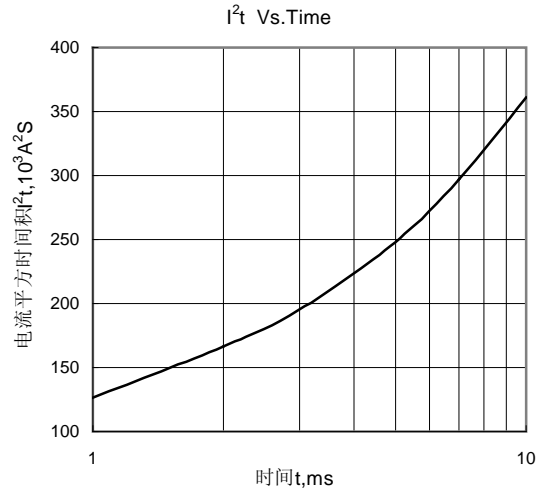

Fig.8 I^2t 特性曲线

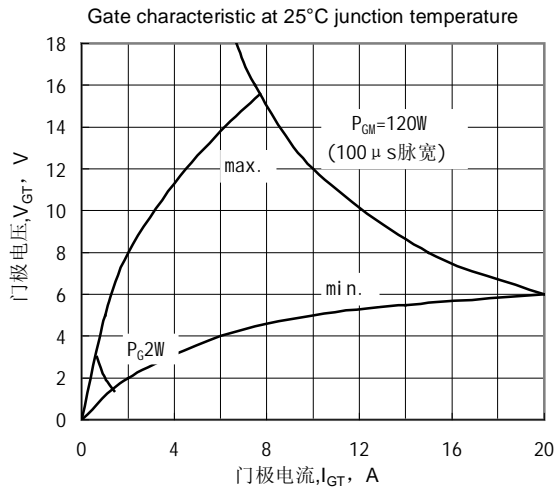

Fig.9 门极功率曲线

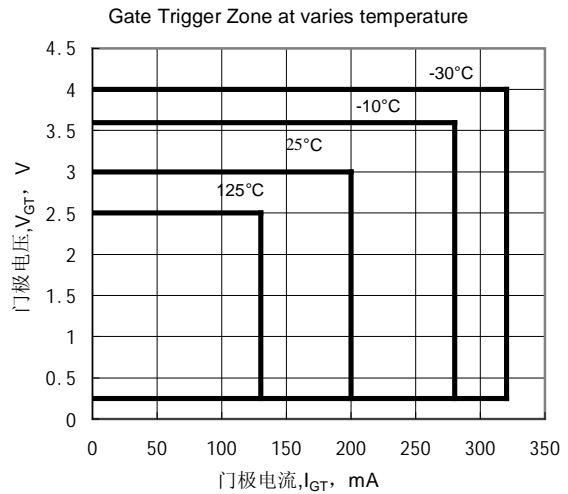
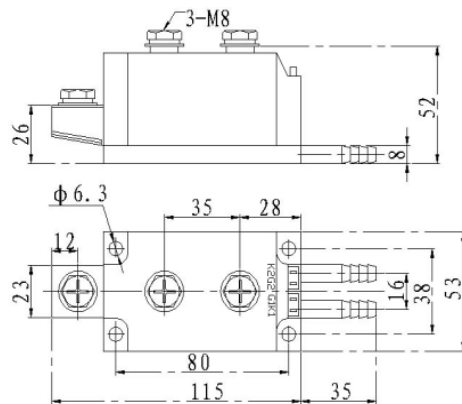

Fig.10 门极触发特性曲线

外形图:



M453S

