



RUNAU

江苏润奥电子制造股份有限公司

MTC350 MTA350 MTK350 MTX350

800V-1800V普通晶闸管模块

RA-DSMTC-009-2017A

特点:

- 芯片与底板电气绝缘,2500V 交流绝缘
- 全压接结构,优良的温度特性和功率循环能力
- 体积小,重量轻

典型应用:

- 交直流电机控制
- 各种整流电源
- 变频器



参数表:

符号	参数	测试条件	结温 Tj(°C)	数值			单位
				最小	典型	最大	
I _{T(AV)}	通态平均电流	180°正弦半波,50Hz 单面散热,Tc=85°C	125			350	A
I _{T(RMS)}	通态电流方均根值		125			550	A
V _{DRM} V _{RRM}	断态重复峰值电压 反向重复峰值电压	V _{DRM} &V _{RRM} tp=10ms V _{DSM} &V _{RSM} =V _{DRM} &V _{RRM} +200V	25	800		1800	V
I _{DRM}	断态重复峰值电流	V _{DM} = V _{DRM}	125			35	mA
I _{RRM}	反向重复峰值电流	V _{RM} = V _{RRM}					
I _{TSM}	通态不重复浪涌电流	10ms 底宽,正弦半波	125			11.0	KA
I ² t	浪涌电流平方时间积	V _R =0.6V _{RRM}				605	A ² s*10 ³
V _{TO}	阈值电压		125			0.80	V
r _T	斜率电阻					0.45	mΩ
V _{TM}	通态峰值电压	I _{TM} =1050A	25			1.50	V
dv/dt	断态电压临界上升率	V _{DM} =67%V _{DRM}	125			1000	V/μs
di/dt	通态电流临界上升率	I _{TM} =750A 门极触发电流幅值 I _{GM} = 1.5A 门极电流上升时间 t _r ≤0.5 s	125			100	A/μs
I _{GT}	门极触发电流	V _O =12V, R _L =3Ω	25	30		120	mA
V _{GT}	门极触发电压			0.8		2.5	V
I _H	维持电流			20		150	mA
I _L	擎住电流					1000	mA
V _{GD}	门极不触发电压	V _{DM} =67%V _{DRM}	125	0.2			V
R _{th(j-c)}	热阻抗(结至壳)	180° 正弦波, 单面散热				0.10	°C/W
R _{th(c-h)}	热阻抗(壳至散)	180° 正弦波, 单面散热				0.04	°C/W
V _{iso}	绝缘电压	50Hz,R.M.S,t=1min,I _{iso} :2mA(MAX)		2500			V
F _m	电极安装扭矩(M8)				12		N·m
	底板安装扭矩(M6)				6		N·m
T _{stg}	贮存温度			-40		125	°C
W _t	质量				870		g

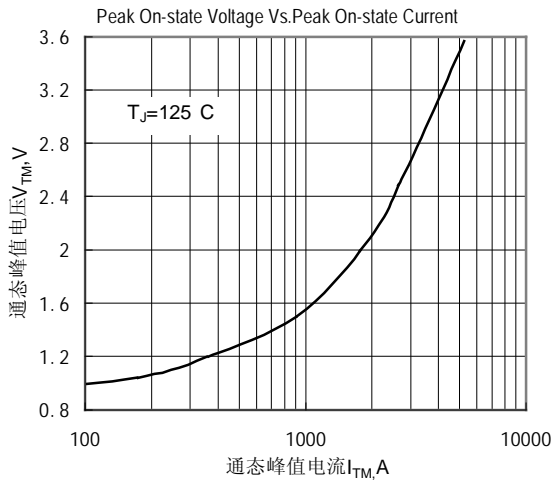

Fig.1 通态伏安特性曲线

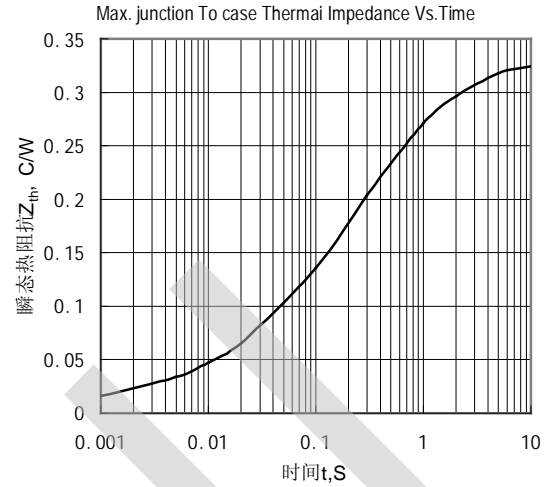

Fig.2 结至管壳瞬态热阻抗曲线

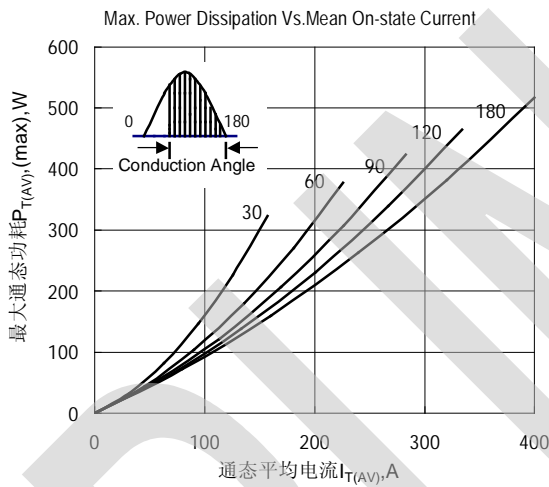

Fig.3 最大功耗与平均电流关系曲线

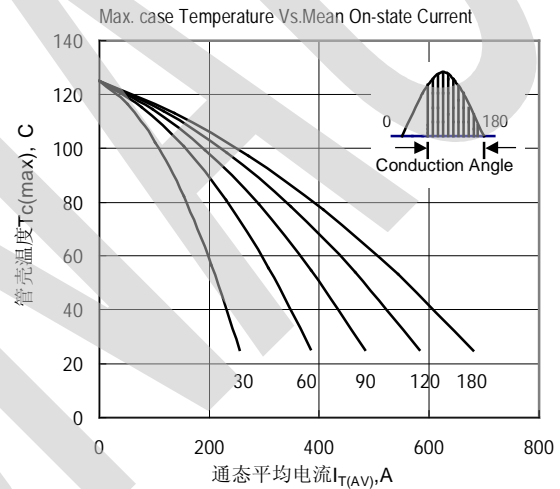

Fig.4 管壳温度与通态平均电流关系曲线

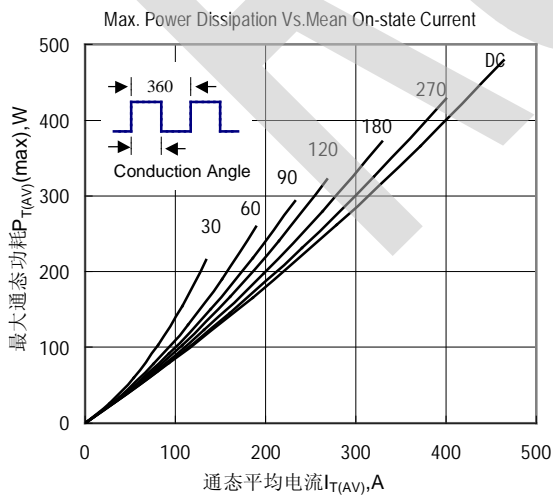

Fig.5 最大功耗与平均电流关系曲线

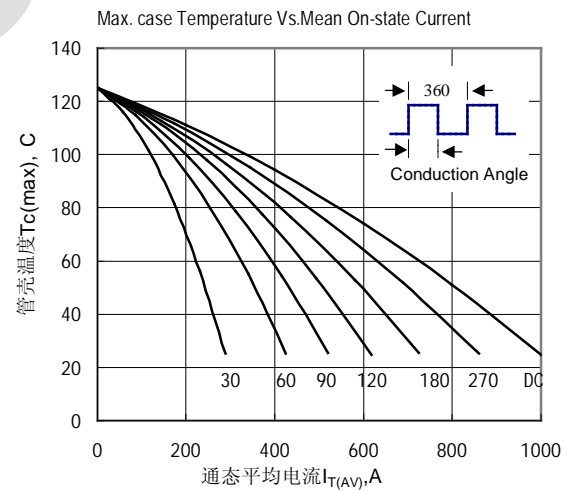

Fig.6 管壳温度与通态平均电流关系曲线

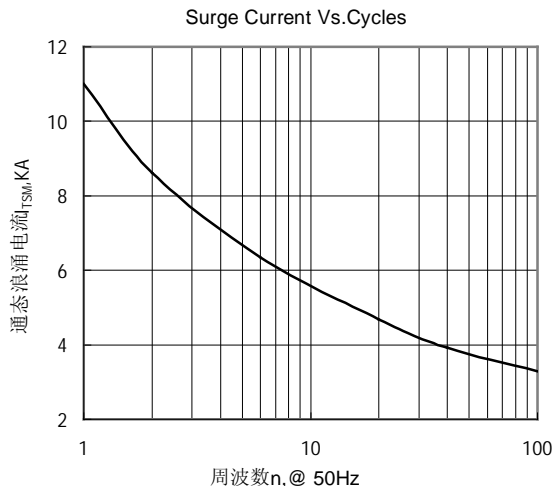

Fig.7 通态浪涌电流与周波数的关系曲线

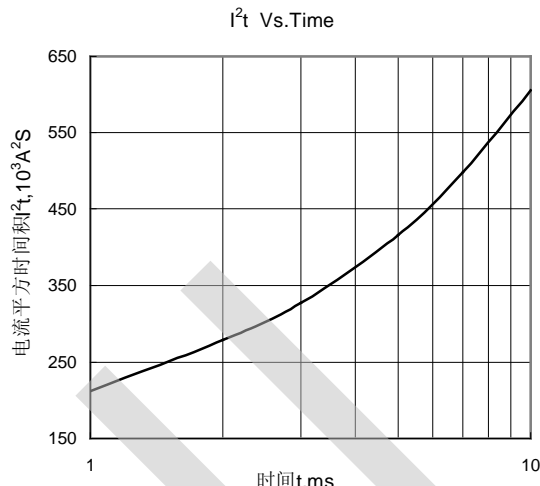

Fig.8 I^2t 特性曲线

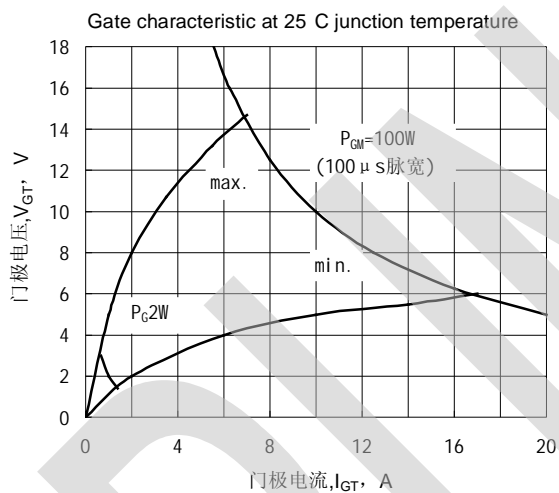

Fig.9 门极功率曲线

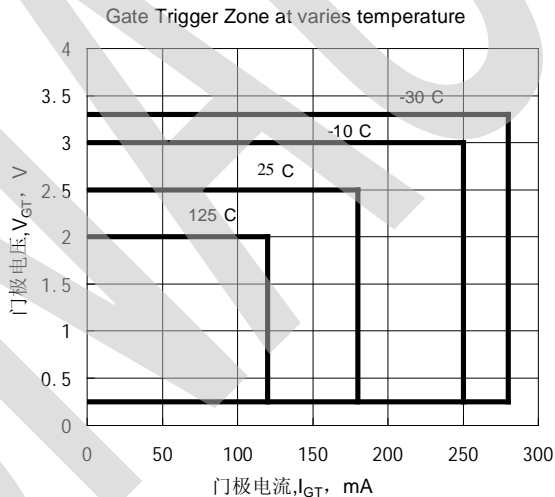
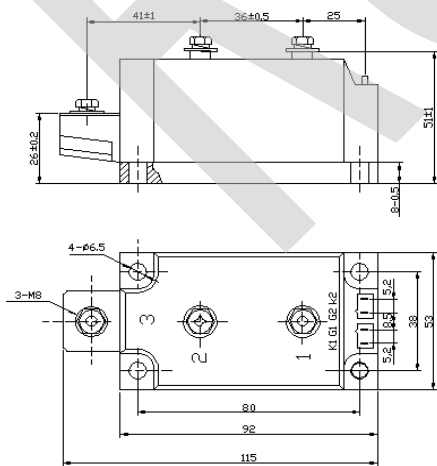

Fig.10 门极触发特性曲线

外形图



M453F

